

ALTERNATION HISTORY RECORDS 变更记录						
Date 日期	Version 版本	Mark 标记	Page 页码	Description 描述	Drafter 制定者	Approver 审批者

1. Application

This specification applies to polar Aluminum electrolytic capacitor (foil type) used in electronic equipment.

Designed capacitor's quality meets IEC60384.

2. Part Number System

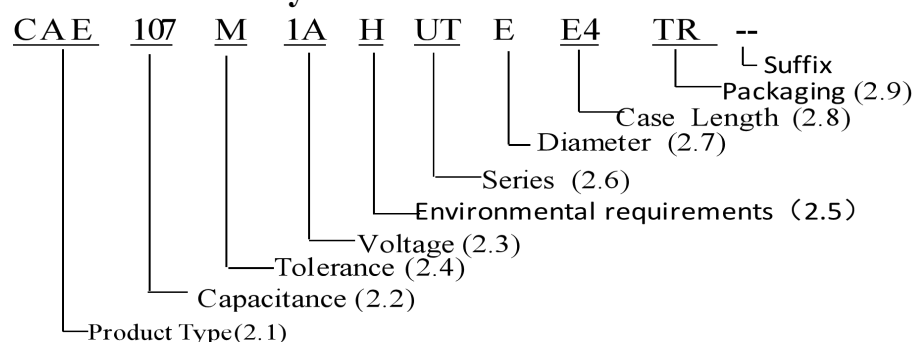

2.1 Product Type :

Code	CAE
Product Type	V-CHIP

2.2 Capacitance code

Code	105	106	107
Capacitance (μF)	1.0	10	100

2.3 Rated voltage code

Code	0J	1A	1C	1E	1V	1H	1J	2A
Voltage (W.V.)	6.3	10	16	25	35	50	63	100

2.4 Capacitance tolerance

Code	M	V
Tolerance Range	±20%	-10%~+20%

2.5 Environmental requirements

Code	R	H
Environmental requirements	ROHS Requirements	ROHS Requirements and Halogen Free

2.6 Products Series Code:

Code	UT
Series	CDUT

2.7 Diameter

Code	C	D	E	F	G	I
Diameter	4	5	6.3	8	10	12.5

2.8 Case length

Code	E4	E7	F5	G7	J2	J5	1A	1B	1C
Case Length(mm)	5.4	5.7	6.5	7.7	10.2	10.5	11.5	12.5	13.5

2.9 Packaging:

Code	TR
Packaging	Taping of Reel

2.10 Suffix: Inner Code

3. Construction

3-1 Inside Construction

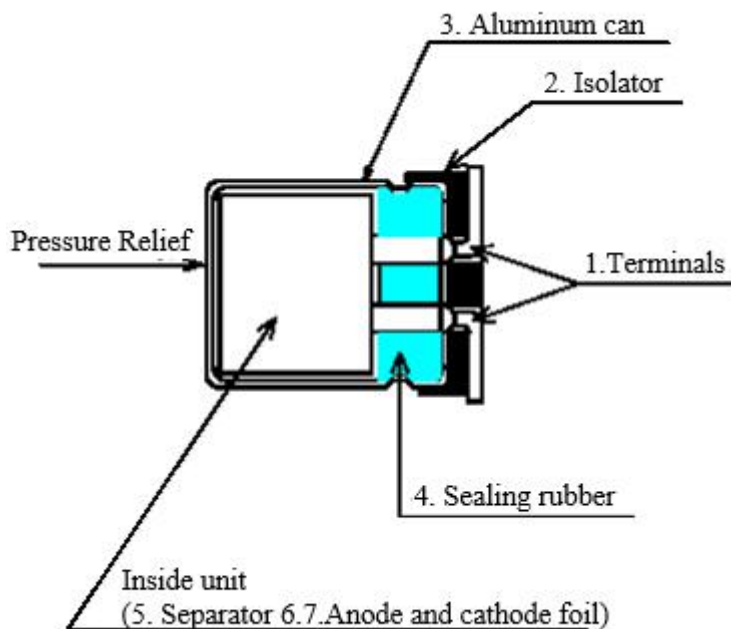

3-2 Construction parts

No.	Parts	Materials	No.	Parts	Materials
1	Terminal	Tinned Copper –Clad Steel wire (Pb Free)	5	Separator	Manila hemp
			6	Anode foil	High purity aluminum foil
2	Isolator	Thermo-plastic resin	7	Cathode foil	Aluminum foil
3	Aluminum can	Aluminum			
4	Sealing Rubber	Synthetic rubber			

4. Characteristics

Standard atmospheric conditions

Unless otherwise specified, the standard range of atmospheric conditions for making measurements and tests is as follows:

Ambient temperature	: 15°C to 35°C
Relative humidity	: 45% to 85%
Air Pressure	: 86kPa to 106kPa

If there is any doubt about the results, measurement shall be made within the following conditions:

Ambient temperature	: 20°C ± 2°C
Relative humidity	: 60% to 70%
Air Pressure	: 86kPa to 106kPa

Operating temperature range

The ambient temperature range at which the capacitor can be operated continuously at rated voltage is -55°C to 105°C.

As to the detailed information, please refer to table 1

Issued-date: 2022-01-05	Name	Specification Sheet – CDUT		
Revision	B		Page	5
STANDARD MANUAL				

Table 1

Item		PERFORMANCE																		
4.1	Nominal capacitance (Tolerance)	<p><Condition> Measuring Frequency : 120Hz±12Hz Measuring Voltage : Not more than 0.5V Measuring Temperature : 20±2°C</p> <p><Criteria> Shall be within the specified capacitance tolerance.</p>																		
4.2	Leakage current	<p><Condition> After DC Voltage is applied to capacitors through the series protective resistor (1kΩ ± 10Ω) so that terminal voltage may reach the reacted use voltage. The leakage current when measured in 2 minutes shall not exceed the values of the following equation.</p> <p><Criteria> $I \leq 0.01CV$ or 3 (μA) whichever is greater.</p> <p>I: Leakage current (μA) C: Capacitance (μF) V: Rated DC Working Voltage (V)</p>																		
4.3	tan δ	<p><Condition> See 4.1, Norm Capacitance, for measuring frequency, voltage and temperature.</p> <p><Criteria> The tangent of the loss angle (tan δ) of the capacitors shall refer to the following table. Measurements shall be made under the same conditions as those given for the measurement of the capacitance.</p> <table border="1"> <tr> <td>WV</td> <td>6.3</td> <td>10</td> <td>16</td> <td>25</td> <td>35</td> <td>50</td> <td>63</td> <td>100</td> </tr> <tr> <td>tan δ</td> <td>0.30</td> <td>0.24</td> <td>0.20</td> <td>0.18</td> <td>0.16</td> <td>0.14</td> <td>0.14</td> <td>0.14</td> </tr> </table>	WV	6.3	10	16	25	35	50	63	100	tan δ	0.30	0.24	0.20	0.18	0.16	0.14	0.14	0.14
WV	6.3	10	16	25	35	50	63	100												
tan δ	0.30	0.24	0.20	0.18	0.16	0.14	0.14	0.14												
4.4	Rated voltage (WV) Surge voltage (SV)	<table border="1"> <tr> <td>WV(V.DC)</td> <td>6.3</td> <td>10</td> <td>16</td> <td>25</td> <td>35</td> <td>50</td> <td>63</td> <td>100</td> </tr> <tr> <td>SV (V.DC)</td> <td>7.2</td> <td>11.5</td> <td>18.4</td> <td>28.8</td> <td>40.2</td> <td>57.5</td> <td>72.5</td> <td>115</td> </tr> </table>	WV(V.DC)	6.3	10	16	25	35	50	63	100	SV (V.DC)	7.2	11.5	18.4	28.8	40.2	57.5	72.5	115
WV(V.DC)	6.3	10	16	25	35	50	63	100												
SV (V.DC)	7.2	11.5	18.4	28.8	40.2	57.5	72.5	115												

4.5

Temperature
characteristic
IEC-60384-4 4.12

<Condition>

STEP	Testing Temperature(°C)	Time
1	20±2	Time to reach thermal equilibrium
2	-55(-25) ±3	Time to reach thermal equilibrium
3	20±2	Time to reach thermal equilibrium
4	105±2	Time to reach thermal equilibrium
5	20±2	Time to reach thermal equilibrium

<Criteria>

- a. At +105°C, capacitance shall be within ±20% of their origin at +20°C, measured capacitance, tan δ shall be within limit of 4.3.
The leakage current value at +105°C shall not more than 8 times the specified value.
- b. At step 5, tan δ shall be within the limit of 4.3.
The leakage current value shall not more than the specified value.
- c. At -55 °C (-25 °C), impedance (Z) ratio shall not exceed the value of the following table.

Rated Voltage (V)		6.3	10	16	25	35	50	63	100
Z-25°C/Z+20°C (120Hz)	<Φ8	4	3	2	2	2	2	2	2
	≥Φ8	5	4	3	2	2	2	2	2
Z-55°C/Z+20°C (120Hz)	<Φ8	12	8	4	4	3	3	3	3
	≥Φ8	8	8	6	4	3	3	3	3

- d. Capacitance, tan δ, and impedance shall be measured at 120Hz.

4.6

Sealing Tape
Reel Strength

<Condition>

Peel angle: 165 to 180° refer to the surface on which the tape is glued.
Peel speed: 300mm per minutes
The peel strength must be 0.1 ~ 0.7N under these conditions.

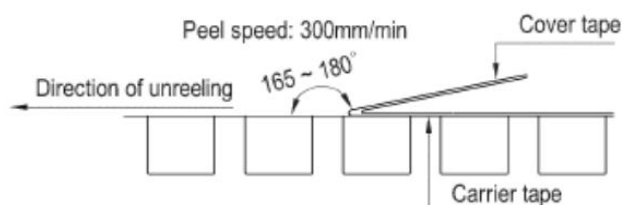

4.7	Load life test IEC-60384-4 4.13	<p><Condition> The capacitor is stored at a temperature of $105^{\circ}\text{C} \pm 2$ with rated voltage applied continuously for 2000+48/0 hours, Then the product should be tested after 16 hours recovering time at atmospheric conditions. The result should meet the following table:</p> <p><Criteria> The characteristic shall meet the following requirements.</p> <table border="1" data-bbox="480 602 1345 842"> <tr> <td>Capacitance Change</td> <td>$\pm 30\%$ of initial measured value.</td> </tr> <tr> <td>tan δ</td> <td>200% or less of the value in 4.3</td> </tr> <tr> <td>Leakage current</td> <td>Not more than the specified value.</td> </tr> <tr> <td>Appearance</td> <td>No leakage of electrolyte or swelling of the case. All markings shall be legible</td> </tr> <tr> <td>Inner construction</td> <td>No corrosion of tab terminals or electrodes</td> </tr> </table> <p>Remarks: Prior to the measurement of the leakage current, the D.C. rated voltage shall be applied across the capacitor and its protective resistance (1 kΩ) for 30 minutes after which it shall be discharged.</p>	Capacitance Change	$\pm 30\%$ of initial measured value.	tan δ	200% or less of the value in 4.3	Leakage current	Not more than the specified value.	Appearance	No leakage of electrolyte or swelling of the case. All markings shall be legible	Inner construction	No corrosion of tab terminals or electrodes
Capacitance Change	$\pm 30\%$ of initial measured value.											
tan δ	200% or less of the value in 4.3											
Leakage current	Not more than the specified value.											
Appearance	No leakage of electrolyte or swelling of the case. All markings shall be legible											
Inner construction	No corrosion of tab terminals or electrodes											
4.8	Shelf life test IEC-60384-4 4.17	<p><Condition> The capacitors are then stored with no voltage applied at a temperature of $105 \pm 2^{\circ}\text{C}$ for 1000+48/0 hours. Following this period the capacitors shall be removed from the test chamber and be allowed to stabilize at room temperature for 4~8 hours. Next they shall be connected to a series limiting resistor ($1\text{k} \pm 100 \Omega$) with D.C. rated voltage applied for 30min. After which the capacitors shall be discharged, and then, tested the characteristics.</p> <p><Criteria> The characteristic shall meet the following requirements.</p> <table border="1" data-bbox="504 1368 1377 1581"> <tr> <td>Change in capacitance</td> <td>$\pm 30\%$ of initial measured value.</td> </tr> <tr> <td>tan δ</td> <td>200% or less of the value in 4.3</td> </tr> <tr> <td>Leakage current</td> <td>Not more than 300% of the specified value</td> </tr> <tr> <td>Appearance</td> <td>No leakage of electrolyte or swelling of the case. All markings shall be legible</td> </tr> <tr> <td>Inner construction</td> <td>No corrosion of tab terminals or electrodes</td> </tr> </table> <p>Remark: If the capacitors are stored more than 1 year, the leakage current may increase. Please apply voltage through about 1K Ω resistor, if necessary.</p>	Change in capacitance	$\pm 30\%$ of initial measured value.	tan δ	200% or less of the value in 4.3	Leakage current	Not more than 300% of the specified value	Appearance	No leakage of electrolyte or swelling of the case. All markings shall be legible	Inner construction	No corrosion of tab terminals or electrodes
Change in capacitance	$\pm 30\%$ of initial measured value.											
tan δ	200% or less of the value in 4.3											
Leakage current	Not more than 300% of the specified value											
Appearance	No leakage of electrolyte or swelling of the case. All markings shall be legible											
Inner construction	No corrosion of tab terminals or electrodes											

4.9
Surge
test
IEC-60384-
4 4.9

<Condition>

Test temperature: 15~35°C

Series resistor: $R = \frac{100 \pm 50}{C}$

R : protective resistor (KΩ)

C : nominal capacitance (μF)

Test voltage: Surge voltage item 4.4

No. of cycles: 1000cycles Each cycles lasts for 6±0.5min
“ON” for 30±5 s “OFF” for 5±0.5min.

<Criteria>

Leakage current	Not more than the specified value.
Capacitance Change	Within ± 15% of initial value.
tan δ	Not more than the specified value.
Appearance	There shall be no leakage of electrolyte.

Attention:

This test simulates over voltage at abnormal situation, and not be hypothesizing that over voltage is always applied.

4.10
Vibration
test
IEC-60384-
4 4.8

<Condition>

Fix it at the point 4 mm or less from body. For ones of 12.5 mm or more in diameter or 25 mm or Capacitance;

Direction and during of vibration: 3 orthogonal directions mutually each for 2 hours (total of 6 hours)

Vibration frequency range : 10Hz ~ 55Hz

Peak to peak amplitude : 1.5mm

Sweep rate : 10Hz ~ 55Hz ~ 10Hz in about 1 minute

<Criteria>

Leakage current	Not more than the specified value.
Capacitance Change	Within ± 10% of initial value.
tan δ	Not more than the specified value.
Appearance	There shall be no leakage of electrolyte.

4.11	Solderability Test IEC-60384-4 4.6	<p><Condition> The capacitor shall be tested under the following conditions: Soldering temperature : 245±3°C Dipping depth : 2mm Dipping speed : 25±2.5mm/s Dipping time : 3±0.5s</p> <p><Criteria></p> <table border="1" data-bbox="550 607 1406 674"> <tr> <td>Coating quality</td> <td>A minimum of 95% of the surface being immersed</td> </tr> </table>	Coating quality	A minimum of 95% of the surface being immersed						
Coating quality	A minimum of 95% of the surface being immersed									
4.12	Resistance to solder heat test	<p><Condition> After reflow soldering (item 4.18 page 13-14) The capacitor shall be left at room temperature for before measurement.</p> <p><Criteria></p> <table border="1" data-bbox="550 954 1307 1111"> <tr> <td>Leakage current</td> <td>Not more than the specified value.</td> </tr> <tr> <td>Capacitance Change</td> <td>Within ±10% of initial value.</td> </tr> <tr> <td>tan δ</td> <td>Not more than the specified value.</td> </tr> <tr> <td>Appearance</td> <td>There shall be no leakage of electrolyte.</td> </tr> </table>	Leakage current	Not more than the specified value.	Capacitance Change	Within ±10% of initial value.	tan δ	Not more than the specified value.	Appearance	There shall be no leakage of electrolyte.
Leakage current	Not more than the specified value.									
Capacitance Change	Within ±10% of initial value.									
tan δ	Not more than the specified value.									
Appearance	There shall be no leakage of electrolyte.									
4.13	Damp heat test IEC60384-4 4.12	<p><Condition> Humidity Test: According to IEC60384-4 No.4.12 methods, capacitor shall be exposed for 1000±8 hours in an atmosphere of 90~95%R H .at 60±3°C, the characteristic change shall meet the following requirement.</p> <p><Criteria></p> <table border="1" data-bbox="536 1435 1326 1592"> <tr> <td>Leakage current</td> <td>Not more than the specified value.</td> </tr> <tr> <td>Capacitance Change</td> <td>Within ±20% of initial value.</td> </tr> <tr> <td>tan δ</td> <td>Not more than 120% of the specified value.</td> </tr> <tr> <td>Appearance</td> <td>There shall be no leakage of electrolyte.</td> </tr> </table>	Leakage current	Not more than the specified value.	Capacitance Change	Within ±20% of initial value.	tan δ	Not more than 120% of the specified value.	Appearance	There shall be no leakage of electrolyte.
Leakage current	Not more than the specified value.									
Capacitance Change	Within ±20% of initial value.									
tan δ	Not more than 120% of the specified value.									
Appearance	There shall be no leakage of electrolyte.									

Issued-date: 2022-01-05	Name	Specification Sheet – CDUT	
Revision	B	Page	10
STANDARD MANUAL			

4.14	Change of temperature test IEC-60384-4 4.7	<p><Condition> Temperature cycle: According to IEC60384-4 No.4.7 methods, capacitor shall be placed in an oven, the condition according as below:</p> <table border="1" data-bbox="566 436 1305 741"> <thead> <tr> <th>Temperature</th> <th>Time</th> </tr> </thead> <tbody> <tr> <td>(1)+25℃</td> <td>≤3 Minutes</td> </tr> <tr> <td>(2) -55℃</td> <td>30±2 Minutes</td> </tr> <tr> <td>(3)+25℃</td> <td>≤3 Minutes</td> </tr> <tr> <td>(4) +105℃</td> <td>30±2 Minutes</td> </tr> <tr> <td>(5)+25℃</td> <td>≤3 Minutes</td> </tr> <tr> <td colspan="2">(1) to (5)=1 cycle, total 5 cycle</td> </tr> </tbody> </table> <p>and then the capacitor shall be subjected to standard atmospheric conditions for 4 hours, after which measurements shall be made.</p> <p><Criteria> The characteristic shall meet the following requirement.</p> <table border="1" data-bbox="566 902 1428 1077"> <tbody> <tr> <td>Capacitance Change</td> <td>Within ±10% of initial value.</td> </tr> <tr> <td>tan δ</td> <td>Not more than the specified value.</td> </tr> <tr> <td>Leakage current</td> <td>Not more than the specified value.</td> </tr> <tr> <td>Appearance</td> <td>No broken and undamaged.</td> </tr> </tbody> </table>	Temperature	Time	(1)+25℃	≤3 Minutes	(2) -55℃	30±2 Minutes	(3)+25℃	≤3 Minutes	(4) +105℃	30±2 Minutes	(5)+25℃	≤3 Minutes	(1) to (5)=1 cycle, total 5 cycle		Capacitance Change	Within ±10% of initial value.	tan δ	Not more than the specified value.	Leakage current	Not more than the specified value.	Appearance	No broken and undamaged.
Temperature	Time																							
(1)+25℃	≤3 Minutes																							
(2) -55℃	30±2 Minutes																							
(3)+25℃	≤3 Minutes																							
(4) +105℃	30±2 Minutes																							
(5)+25℃	≤3 Minutes																							
(1) to (5)=1 cycle, total 5 cycle																								
Capacitance Change	Within ±10% of initial value.																							
tan δ	Not more than the specified value.																							
Leakage current	Not more than the specified value.																							
Appearance	No broken and undamaged.																							
4.15	Low Temperature Test	<p><Condition> Capacitors are placed at $-55 \pm 3^\circ\text{C}$ for 96 ± 4 hours. And then the capacitor shall be subjected to standard atmospheric conditions for 4 hours, after which measurements shall be made.</p> <p><Criteria></p> <table border="1" data-bbox="518 1391 1385 1565"> <tbody> <tr> <td>Leakage current</td> <td>Not more than the specified value.</td> </tr> <tr> <td>Capacitance Change</td> <td>Within ± 10% of initial value</td> </tr> <tr> <td>tan δ</td> <td>Not more than the specified value.</td> </tr> <tr> <td>Appearance</td> <td>No broken and undamaged</td> </tr> </tbody> </table>	Leakage current	Not more than the specified value.	Capacitance Change	Within ± 10% of initial value	tan δ	Not more than the specified value.	Appearance	No broken and undamaged														
Leakage current	Not more than the specified value.																							
Capacitance Change	Within ± 10% of initial value																							
tan δ	Not more than the specified value.																							
Appearance	No broken and undamaged																							

4.16

Vent
Test
IEC-60384-4 4.16

<Condition>

The following test only apply to those products with vent products at diameter $\geq \varnothing 8$ with vent.

D.C. test

The capacitor is connected with its polarity reversed to a DC power source. Then a current selected from Table 2 is applied.

<Table 2>

Diameter (mm)	DC Current (A)
22.4 or less	1

<Criteria>

No emission of gas after 30 minutes of the voltage application also meets the specification. The vent shall operate with no dangerous conditions such as flames or dispersion of pieces of the capacitor and/or case.

4.17

Mechanical
Characte
ristics
Test

<Condition>

Bending Test:

Apply pressure in the direction of the arrow at a rate of about 0.5 mm / s until bent width reaches 2 mm and hold for 60s. The board shall be the test board "B" as specified in JIS C 0051: 2002. If the land area differs, it shall be specified clearly in the next item.

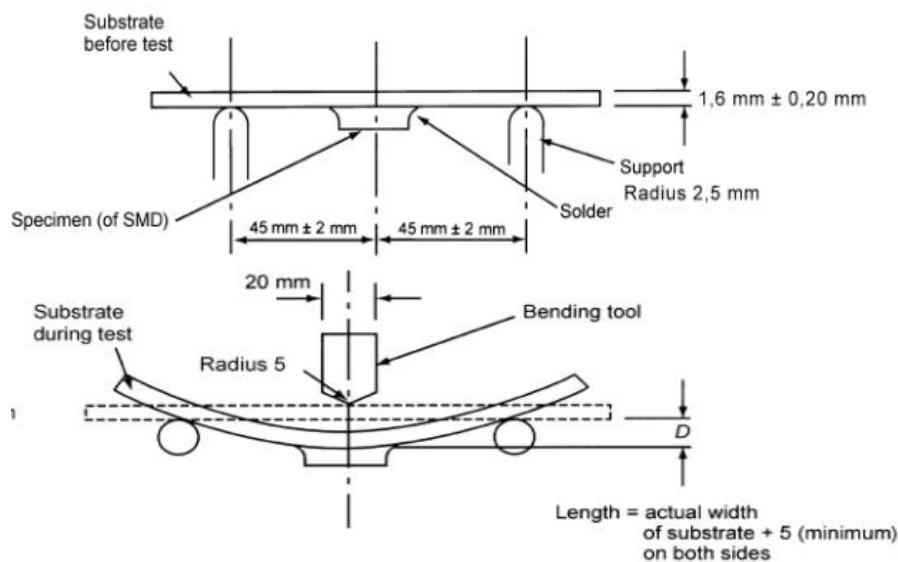

<Criteria>

Without mechanical damage such as breaks. Electrical characteristics shall be satisfied. If there are electrodes on both surfaces, above requirements shall be satisfied on whichever surface it may be fixated on.

Issued-date: 2022-01-05

Name

Specification Sheet – CDUT

Revision

B

Page

12

4.18

Reflow
soldering
temperature
profile

Welding method	Reflow soldering	Soldering iron	Wave soldering
The feasibility of	○ feasible	○ feasible	× Is not workable

Conditions for the use of lead-free reflow soldering. :

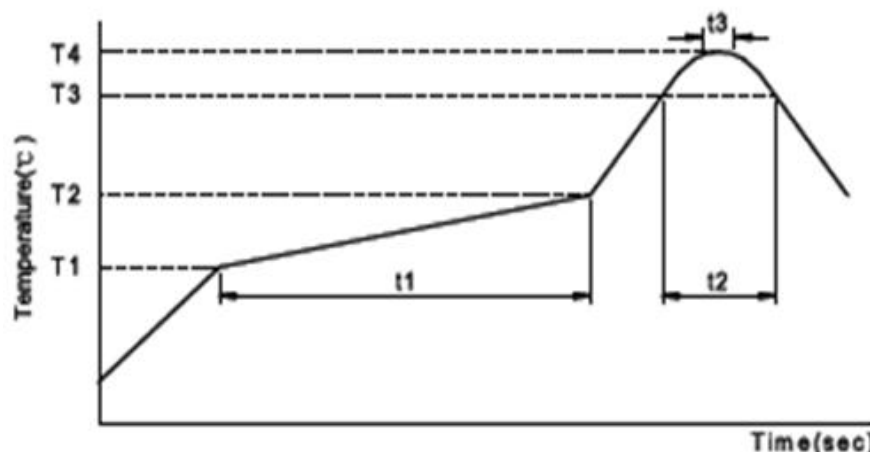

1)Methods the following:

Reflow soldering: please follow the temperature condition during welding. If high temperature is used, please measure and inform the capacitor temperature and reflow soldering condition. The product size is larger and its rising temperature is slower. It is not necessary to adjust the temperature of the reflow solder in accordance with the size of the product. For example, the products of 4 and 10 will be installed in the PCB over tin furnace.

2) Precautions for soldering tin :

Related factors of reflow soldering temperature:

Product size : The product size is larger and its temperature rises slowly.

Product installation position: The temperature of PCB center is lower than that of PCB °

3) Reflow soldering :

If possible, avoid reflow soldering twice.

If repeated reflux is unavoidable, measure and inform the first and second reflux temperature, and the time of reflow soldering

4) Please do not 3 times of reflow soldering

Please follow the following conditions when soldering tin soldering:

Soldering iron maximum temperature : $350 \pm 5^{\circ}\text{C}$

Welding time : $3+1/-0\text{S}$

4.18

Reflow
soldering
temperature
profile

Test method and peak temperature permissible range

Products category		SMD aluminum electrolytic capacitor							
voltage (V)		4~50		≥63		4~100		≥160	
Product size		Φ4~6.3		Φ4~6.3		Φ8~18		≥Φ12.5	
Preheating	TEM (T ₁ ~T ₂ , °C)	150~180							
	Time (t ₁) Max, S	180							
The duration of the	TEM (T ₃ , °C)	217	230	217	217	230	217		
	Time (t ₂) Max, S	90	60	60	60	40	60		
The highest temperature	TEM (T ₄ , °C)	260		250		250		240	
	Time (t ₃) Max, S	5							
Return the number		≤2							

* Please contact us if the conditions of use are higher than those listed above.

* When performing second reflow soldering, please make sure the temperature of capacitor has cooled to 5 ~ 35 °C.

* If the reflow condition is based on IPC/JEDEC(J-STD-020), please contact us. °

●OP-CAP Precautions:

Reflow soldering will reduce the rated electrostatic capacity of the product, and it should be confirmed whether reflow soldering condition meets the specification of recommended reflow soldering. °

Although the actual reflow condition change is still based on the reflow soldering method, please note that the highest temperature and the electrode terminal at the bottom of the aluminum shell must not exceed the maximum temperature.

OP - CAP products during the process of reflow heating temperature should increase to more than 200 °C °

If the reflow condition temperature or duration is greater than the above table, the OP-CAP product will be damaged. The electrostatic capacity of the product is reduced by about 50%, the leakage current is large (up to mA), and the outside of the capacitor is damaged.

●Recommended Land Size (Unit: mm)

尺寸Size	X	Y	G
Φ4	1.6	2.6	1.0
Φ5	1.6	3.0	1.4
Φ6.3	1.6	3.5	1.9
Φ8	2.5	3.5	3.0
Φ10	2.5	4.0	4.0
Φ12.5	3.2	4.0	6.0

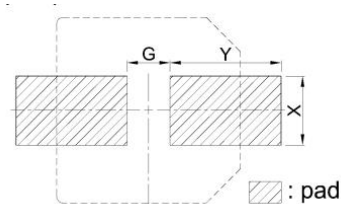

5. Product Dimensions & Maximum Permissible Ripple Current

Size : \varnothing D X L (mm) , Maximum Allowable Ripple Current (mAr.m.s/+105°C,120 Hz)

μ F	WV	6.3		10		16		25	
	Item	D×L	Ripple Current	D×L	Ripple Current	D×L	Ripple Current	D×L	Ripple Current
4.7								4x5.4	17
10						4x5.4	20	4x5.4 5x5.4	20 25
22	4x5.4	22	4x5.4 5x5.4	21 26	4x5.4 5x5.4	20 30	5x5.4 6.3x5.4	30 45	
33	4x5.4 5x5.4	26 34	4x5.4 5x5.4	23 34	5x5.4 6.3x5.4	34 45	5x5.4 6.3x5.4	35 45	
47	4x5.4 5x5.4	30 38	5x5.4 6.3x5.4	36 42	5x5.4 6.3x5.4	38 48	6.3x5.4 8x6.5	49 79	
68							6.3x5.4	60	
100	5x5.4 6.3x5.4	50 69	5x5.4 6.3x5.4	50 69	6.3x5.4 6.3x7.7 8x6.5	69 85 90	6.3x7.7	100	
220	6.3x5.4 6.3x7.7	80 120	6.3x5.4 6.3x7.7 8x6.5	80 120 120	6.3x7.7 8x6.5	120 120	8x10.2	270	
330	6.3x7.7	135	6.3x7.7 8x10.2	135 260	8x10.2	290	8x10.2 10x10.2	290 340	
470	6.3x7.7 8x10.2	160 320	6.3x7.7 8x10.2 10x10.2	160 320 360	8x10.2 10x10.2	300 380	10x10.2	380	
680	8x10.2	360	10x10.2	380	10x10.2	400	12.5x13.5	460	
1000	8x10.2 10x10.2	380 410	10x10.2	410	10x10.2	450	12.5x13.5	500	
1500	10x10.2	450	12.5x13.5	540	12.5x13.5	540			
2200	12.5x13.5	680	12.5x13.5	680					

Size : ϕ D X L (mm) , Ripple Current (mA r.m.s/+105°C,120 Hz)

μ F	WV	35		50		63		100	
	Item	D×L	Ripple Current	D×L	Ripple Current	D×L	Ripple Current	D×L	Ripple Current
1				4x5.4	8.0	4x5.4	8	4x5.4	7.2
2.2				4x5.4	12	4x5.4	12	6.3x5.4	15
3.3		4x5.4	17	4x5.4	14	5x5.4	14	6.3x5.4	22
4.7		4x5.4	18	4x5.4	14	5x5.4	20	5x5.4	19
				5x5.4	20	6.3x5.4	24	6.3x7.7	38
10		4x5.4	22	5x5.4	25	6.3x5.4	32	6.3x7.7	38
		5x5.4	27	6.3x5.4	32	6.3x7.7	45	8x10.2	80
22		5x5.4	35	6.3x5.4	43	6.3x7.7	58	8x10.2	100
		6.3x5.4	44	6.3x7.7	52	8x10.2	110	10x10.2	130
33		6.3x5.4	45	6.3x7.7	65	8x10.2	140	10x10.2	150
		8x6.5	76	8x6.5	70				
47		6.3x5.4	54	6.3x7.7	70	8x10.2 10x10.2	170 200	10x10.2	180
		6.3x7.7	80	8x6.5	75				
		8x6.5	85	8x10.2	150				
100		6.3x7.7	90	8x10.2	210	8x10.2 10x10.2	210 300	12.5x13.5	380
		8x10.2	240	10x10.2	250				
220		8x10.2	270	10x10.2	330	12.5x13.5	470		
		10x10.2	300						
330		8x10.2	290	12.5x13.5	490				
		10x10.2	370						
470		10x10.2	380	12.5x13.5	520				
680		12.5x13.5	540						

Remark:

- 1)Specification are subject to change without notice should a safety or technical concern arise regarding the product please be sure to contact our sales offices;
- 2)The sizes in the above table are all general specifications. If you need other specifications, please contact us.

Frequency Coefficient of Allowable Ripple Current:

Frequency	50Hz	120Hz	300Hz	1kHz	≥10kHz
Coefficient	0.70	1.00	1.17	1.36	1.50

Temperature coefficient

Ambient Temperature(°C)	105	85	≤70
Coefficient	1.0	1.5	2.0

6. Marking :

Capacitors shall be legibly marked with the following:

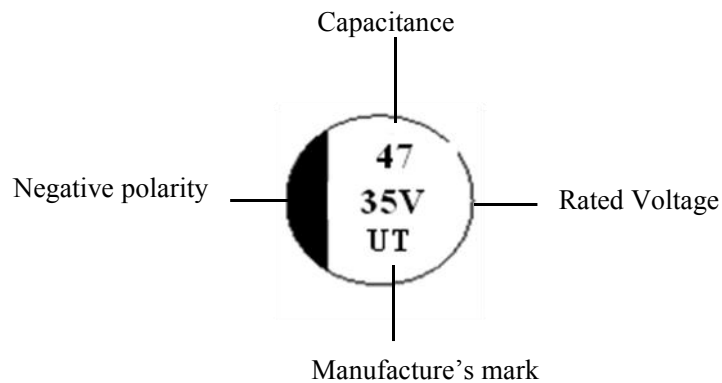

7.Dimensions :

Unit: mm

Ø4 ~ Ø6.3 Non explosion proof valve ,
Ø8 ~ Ø12.5 Explosion proof valve

Ø4 ~ Ø10

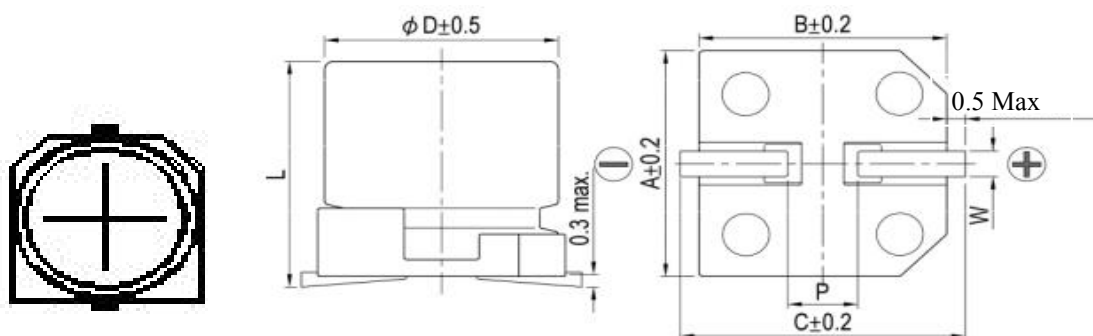

Ø12.5~Ø18

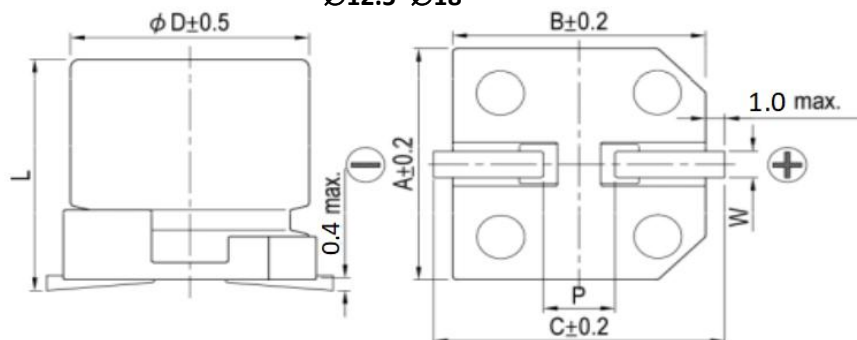

Dimensions (Unit: mm)

Size	Φ4×5.4	Φ5×5.4	Φ6.3×5.4	Φ6.3×7.7	Φ8×6.5	Φ8×10.2	Φ10×10.2	Φ12.5×13.5
A	4.3	5.3	6.6	6.6	8.3	8.3	10.3	13.0
B	4.3	5.3	6.6	6.6	8.3	8.3	10.3	13.0
C	5.1	5.9	7.2	7.2	9.0	9.0	11.0	13.7
W	0.5~0.8	0.5~0.8	0.5~0.8	0.5~0.8	0.5~0.8	0.7~1.1	0.7~1.3	1.1~1.4
P	1.0±0.2	1.5±0.2	2.1±0.2	2.1±0.2	3.1±0.2	3.1±0.2	4.5±0.2	4.4±0.2
L	5.4 -0.3/+0.5	5.4 -0.3/+0.5	5.4 -0.3/+0.5	7.7 -0.3/+0.5	6.5 -0.3/+0.5	10.2±0.5	10.2±0.5	13.5±0.5

Issued-date: 2022-01-05

Name

Specification Sheet – CDUT

Revision

B

Page

18

8. Taping Specifications:

Applicable standard JIS C0806 and IEC 60286.

8.1 Carrier Tape and Dimension

Fig.1 (Ø4 ~ Ø18)

Fig. 1-1

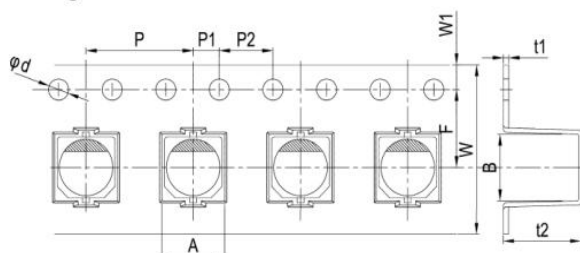
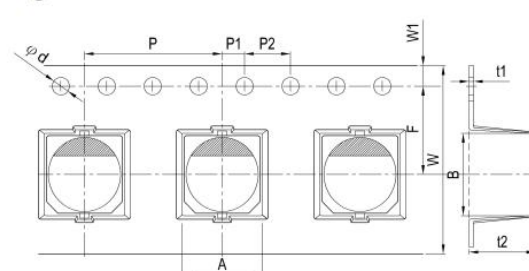
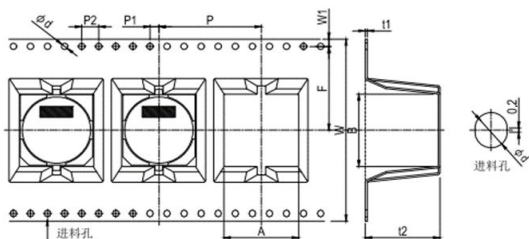

Fig. 1-2



Size	W (mm)	P (mm)	F (mm)	A ₀ (mm)	B ₀ (mm)	T ₂ (mm)	Ød	P1	P2	t1	W1	Applicable	
Φ4*5.4	12	8	5.5	4.7	4.7	5.8	1.5	2.0	4.0	0.4	1.75	Fig.1-1	
Φ5*5.4	12	12	5.5	6.0	6.0	5.8	1.5	2.0	4.0	0.4	1.75		
Φ6.3*5.4	16	12	7.5	7.0	7.0	5.8	1.5	2.0	4.0	0.4	1.75		
Φ6.3*7.7	16	12	7.5	7.0	7.0	8.3	1.5	2.0	4.0	0.4	1.75		
Φ6.3*10.2	16	12	7.5	7.0	7.0	11.0	1.5	2.0	4.0	0.4	1.75		
Φ8*6.5	16	12	7.5	8.7	8.7	6.8	1.5	2.0	4.0	0.4	1.75		Fig.1-2
Φ8*10.2	24	16	11.5	8.7	8.7	11.0	1.5	2.0	4.0	0.4	1.75		
Φ8*12.5	24	16	11.5	8.7	8.7	13.0	1.5	2.0	4.0	0.4	1.75		
Φ10*10.2	24	16	11.5	10.7	10.7	11.0	1.5	2.0	4.0	0.4	1.75		
Φ10*12.5	24	16	11.5	10.7	10.7	13.0	1.5	2.0	4.0	0.4	1.75		
Φ10*13.5	24	16	11.5	10.7	10.7	13.0	1.5	2.0	4.0	0.4	1.75		

Fig1-3(Ø12.5 ~ Ø18)



Size	W (mm)	P (mm)	F (mm)	A (mm)	B (mm)	t ₂ (mm)	Φd	P ₁	P ₂	t ₁	W ₁	Applicable
Φ12.5*13.5	32	24	14.2	13.4	13.4	14.5	1.5	2.0	4.0	0.5	1.75	Fig.1-3
Φ12.5*16	32	24	14.2	13.4	13.4	17	1.5	2.0	4.0	0.5	1.75	
Φ16*16.5	44	28	20.2	17.5	17.5	17.5	1.5	2.0	4.0	0.5	1.75	
Φ16*21.5	44	28	20.2	17.5	17.5	22.5	1.5	2.0	4.0	0.5	1.75	
Φ18*16.5	44	32	20.2	19.5	19.5	17.5	1.5	2.0	4.0	0.5	1.75	

Issued-date: 2022-01-05

Name

Specification Sheet – CDUT

Revision

B

Page

19

8.2 Reel Package:
Fig. 2-1

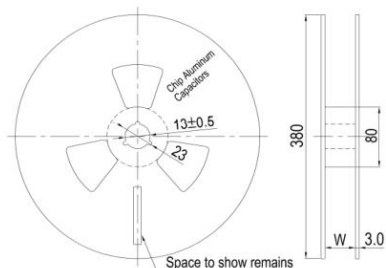
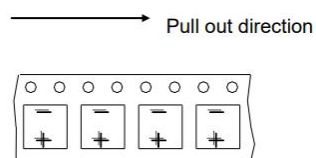

Fig. 2-2 Reel Polarity



Case size	Ø4	Ø5	Ø6.3	Ø8x6.5	Ø8x10.2/10.5	Ø10	Ø12.5
W	14	14	18	18	26	26	34

9. Packing Method

9.1 Polarity: Anode on the opposite side of the feed hole

9.2 The leader length of the tape shall not be less than 400mm including 10 or more embossed sections in which no parts are contained.

9.3 The winding core is provided with an over 40mm long empty section.

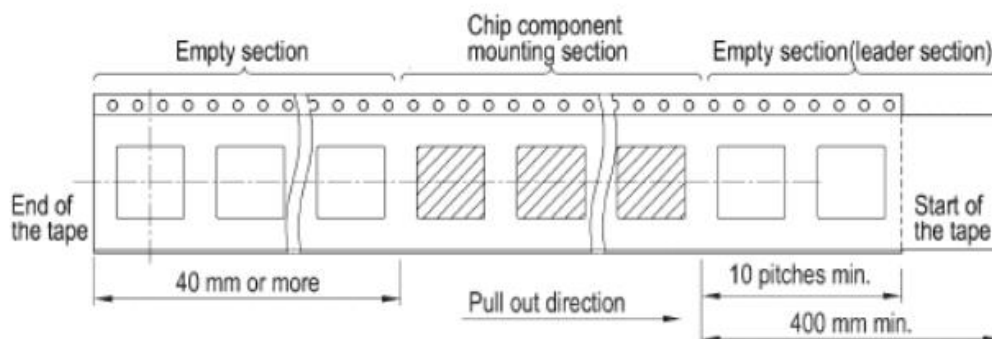

10. Application guideline for V-CHIP aluminum electrolytic capacitors

10.1 Circuit Design:

- 1) Please make sure the environmental and mounting conditions to which the capacitor will be exposed are within the conditions specified in catalogue.
- 2) Operating temperature and applied ripple shall be within specification.
- 3) Appropriate capacitors which comply with the life requirement of the products should be selected when designing the circuit.
- 4) Aluminum electrolytic capacitors are polar. Make sure that no reverse voltage or AC voltage is applied to the capacitors. Please use bi-polar capacitors for a circuit that can possibly see reversed polarity.

Note: Even bi-polar capacitors cannot be used for AC voltage application.

- 5) Do not use aluminum electrolytic capacitors in a circuit that requires rapid and very frequent charge / discharge. In this type of circuit, it is necessary to use a special design capacitor with extended life characteristics.
- 6) Do not apply excess voltage.
 - Please pay attention to that the peak voltage, which is DC voltage overlapped by ripple current, will not exceed the rated voltage.
 - In the case where more than 2 aluminum electrolytic capacitors are used in series, please make sure that applied voltage will be lower than rated voltage and the voltage will be applied to each capacitor equally by using a balancing resistor in parallel with the capacitor
- 7) Aluminum electrolytic capacitors shall not be used under the following environmental conditions:
 - Capacitors will be exposed to water (including condensation), brine or oil.
 - Ambient conditions that include toxic gases such as hydrogen sulfide, sulfurous acid, nitrous acid, chlorine, bromine, methyl bromide, ammonium, etc.
 - Ambient conditions that expose the capacitor to ozone, ultraviolet ray and radiation.
 - Severe vibration and physical shock conditions that exceed specification.

Vibration test condition:

vibration frequency range : 10~55~10Hz

sweep rate : 10~55~10Hz/minute

sweep method : logarithmic

amplitude or acceleration : 1.5mm (max. acceleration is 10G)

direction of vibration : X, Y, Z direction

testing time: 2 hours per each direction

Shock is not applicable normally.

If a particular condition is required, please contact our sales office.

Issued-date: 2022-01-05

Name

Specification Sheet – CDUT

Revision

B

Page

21

- 8) The main chemical solution of the electrolyte and the separator paper used in the capacitors are combustible. The electrolyte is conductive. When it comes in contact with the PC board, there is a possibility of pattern corrosion or short circuit between the circuit pattern, which could result in smoking or catching fire. Do not locate any circuit pattern beneath the capacitor end seal.
- 9) Do not design a circuit board that the heat generating components are placed near the aluminum electrolytic capacitor or on the reverse side of PC board, if that just under the capacitor.
- 10) Electrical characteristics may vary depending on changes in temperature and frequency.
Please consider this variation when you design circuits.
- 11) When you install more than 2 capacitors in parallel, please consider the balance of current flowing into the capacitors.
- 12) While mounting capacitors on double-side PC board, the capacitors should be away from those unnecessary base plate holes and connection holes.

10.2 Mounting

- 1) Once a capacitor has been assembled in the set and power applied, do not attempt to re-use the capacitor in other circuits or application.
- 2) Leakage current of the capacitors that have been stored for more than 2 years may increase.
When leakage current has increased, please perform a voltage treatment using a 1kΩ resistor.
- 3) Please confirm specifications and polarity before installing capacitors on the PC board.
- 4) Do not drop capacitors on the floor, nor use a capacitor that was dropped.
- 5) Do not deform the capacitor during installation.
- 6) Please pay attention to the mechanical shock to the capacitor by suction nozzle of the automatic insertion machine or automatic mounter, or by product checker, or by centering mechanism.

10.3 Reflow soldering

- 1) Please follow “Reflow Soldering Conditions” in catalogue.
- 2) When an infrared heater is used, please pay attention to the extent of heating since the absorption rate of infrared will vary due to difference in the color and size of the capacitor.
- 3) Do not tilt lay down or twist the capacitor body after the capacitor are soldered to the PC board.
- 4) Do not carry the PC board by grasping the soldered capacitor.
- 5) Please do not allow anything to touch the capacitor after soldering. If PC boards are stored in stack, please make sure the PC board or other components away from the capacitor.
- 6) The capacitors shall not be effected by any radiated heat from the soldered PC board or other components after soldering.

7) Cleaning

- (1) Do not clean capacitors with halogenated cleaning agent. However, if it is necessary to clean with halogenated cleaning agent, please contact our sales office.
- (2) Recommended cleaning method:

Applicable : Any type, any ratings

Cleaning conditions : Total cleaning time shall be within 2 minutes by immersion, ultrasonic or other methods.

Temperature of the cleaning agents shall be 40°C or below. After cleaning, capacitors should be dried by using hot air for the minimum 10 minutes along with the PC board mounted. Hot air temperature should be within the maximum operating temperature of the capacitor. Insufficient dryness after water rinse may cause appearance problems, such as bottom-plate bulge and etc.

- (3) Avoid using ozone destructive substances as cleaning agents for protecting global environment.

10.4 In the Equipment

- 1) Do not directly touch terminal by hand.
- 2) Do not link positive terminal and negative terminal by conductor, nor spill conductible liquid such as alkaline or acidic solution on or near the capacitor.
- 3) Please make sure that the ambient conditions where the set is installed are free from spilling water or oil, direct sunlight, ultraviolet rays, radiation, poisonous gases, vibration or mechanical shock.

10.5 Maintenance and Inspection

Please periodically inspect the aluminum capacitors that are installed in industrial equipment. The following items should be checked:

Appearance: remarkable abnormality such as pressure relief vent opening, electrolyte leaking, etc.

Electrical characteristics: capacitance, dielectric loss tangent, leakage current and etc., which are specified in catalogue or alternate product specification.

10.6 In an Emergency

- 1) If you see smoke due to operation of safety vent, please turn off the main switch or pull out the plug from the outlet.
- 2) If you breathe the gas or ingest the electrolyte, please wash out your mouth and throat with water immediately.
- 3) If your skin is exposed to the electrolyte, please wash it away using soap and water.

10.7 Storage

1) Do not keep capacitor in high temperature and high humidity atmosphere. Storage conditions should be:
 Temperature: 5°C ~ 35°C Humidity : lower than 75% Place : Indoor

2) Avoid ambient conditions where capacitors are covered with water, brine or oil.

3) Avoid ambient conditions where capacitors are exposed to ozone, ultraviolet ray or radiation.

10.8 Disposal

Please take either of the following methods in disposing capacitors.

1) Incinerate them after crushing capacitors or making a hole on the capacitor body.

2) If incineration is not applicable, hand them over to a waste disposal agent and have them buried in landfills.